







Caractéristiques

Tension	100 - 240 V~
Fréquence	50 - 60 Hz
	2 x 1,5 mm ²
	Profondeur = mini. 40 mm
Norme	Courant porteur EN 50065 IEC 60669-2-1
	+ 5°C à + 45°C

Charges

	①	②	③
			
110 V	150 W	150 W	150 W
230 V	300 W	300 W	300 W

- ① Lampe incandescente
- ② Lampe halogène
- ③ Lampe halogène TBT à transformateur ferromagnétique ou électronique

Protection par dispositif électronique :

- En cas de surcharge et au-delà de la température maxi d'utilisation, le produit régule automatiquement la puissance par diminution de l'éclairage.
- En cas de court-circuit ou de très forte surcharge, l'intervariateur se met hors service. Après élimination du défaut, le produit est à nouveau fonctionnel.

Branchement

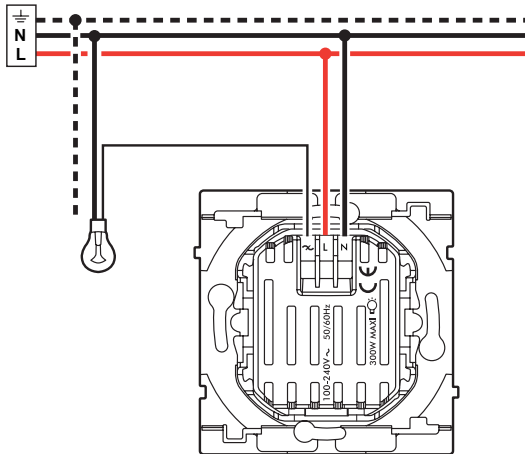

Configuration d'usine

A la première mise sous tension l'appui sur les touches ON et OFF commande l'ensemble des points d'éclairage de l'installation "In One by Legrand". L'appui sur Learn⁽¹⁾ annule cette fonction de commande générale.

- (1) Touche de programmation ou apprentissage.

Description

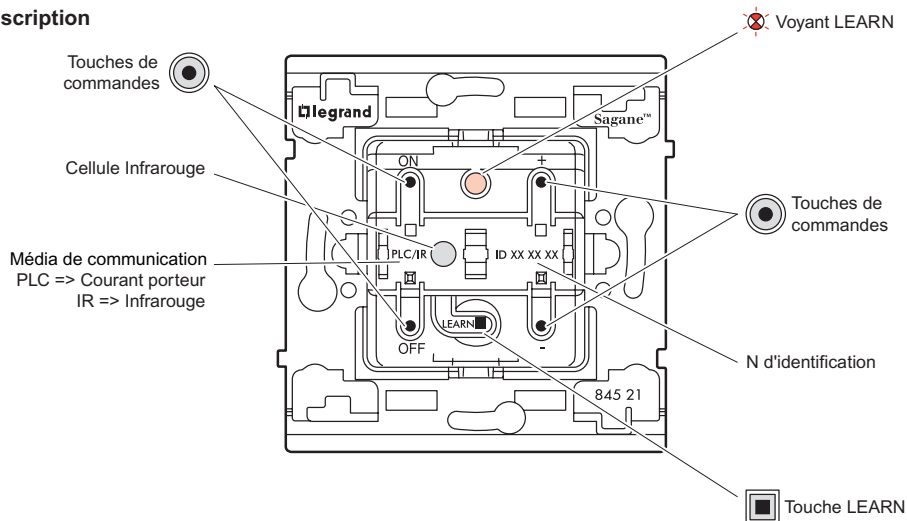

Fonctionnement

L'intervariateur :

- peut commander simultanément à partir de ses touches ON et OFF un ensemble de produits (acteurs) qui lui sont associés lors de son apprentissage⁽¹⁾, il est alors **Leader** du scénario⁽²⁾.
- peut-être commandé par d'autres produits leaders, il est alors **Acteur**.

En Leader :

L'intervariateur permet de commander :

- les points d'éclairage à partir des touches ON, OFF.
- les points d'éclairage qui lui sont associés, lors de l'apprentissage (les acteurs).

En Acteur :

L'intervariateur peut participer à 16 scénarios différents, en exécutant localement les commandes provenant des autres leaders.

Il possède une interface pour les signaux infrarouges qui permet la commande de ses scénarios et/ou d'autres produits de l'installation.

En local :

L'intervariateur permet de commander les points d'éclairage à partir des touches ON, OFF, + et -, qui sont reliés directement à la borne de phase coupée.

Réglage du niveau lumineux de la touche ON (hors procédure d'apprentissage) :

- régler le niveau lumineux à l'aide des touches + et -,
- appuyer simultanément sur les touches + et ON durant 5 secondes
- la charge s'éteint et se rallume au niveau ON.

Le niveau ON est alors enregistré.

Pour enregistrer un niveau lumineux lors de l'apprentissage, l'étape 2 de l'**Apprentissage du scénario** devient :

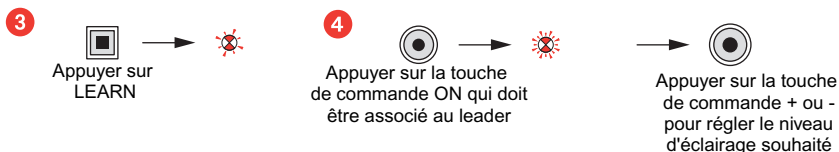

(1) Apprentissage : action d'associer des produits en vue de les commander simultanément à partir d'un point central.

Cette association se réalise en appliquant la procédure d'**apprentissage du scénario** en page 3.

(2) Scénario : correspond à l'ensemble des produits (acteurs) qui sont associés à une touche de commande.

Apprentissage du scénario

Etape 1 : débiter l'apprentissage (sur le LEADER)

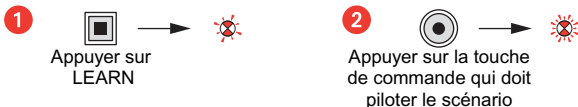

Etape 2 : ajouter un acteur au scénario (sur l'ACTEUR)



Etape 3 : enregistrer le scénario (sur le LEADER)

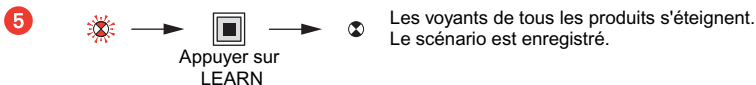

Modification d'un scénario

Etape 1 : ouvrir le scénario (sur le LEADER)



Etape 2 : modifier l'état d'un acteur du scénario (sur l'ACTEUR)

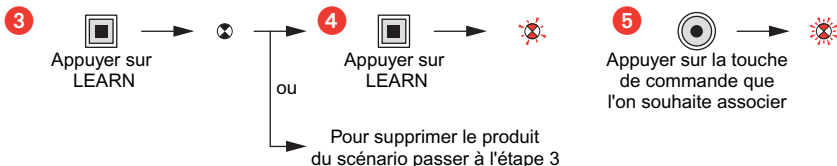

Etape 3 : enregistrer le scénario (sur le LEADER)

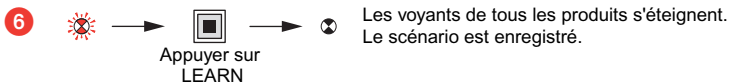

Effacement d'un scénario

Effacer tous les scénarios liés à la touche de commande (sur le LEADER)





Effacer tous les scénarios liés à ce produit (sur le LEADER)





Légende

 Le voyant s'éteint  Le voyant clignote lentement  Le voyant clignote rapidement  Le voyant flashe

Eigenschappen

Spanning	100 - 240 V \sim
Frequentie	50 - 60 Hz
	2 x 1,5 mm ²
	Diepte = mini. 40 mm
Norm	Draaggolf EN 50065 IEC 60669-2-1
	+ 5°C tot + 45°C

Belasting

	①	②	③
			
110 V	150 W	150 W	150 W
230 V	300 W	300 W	300 W

- ① Gloeilamp
- ② Halogeenlamp
- ③ Halogeenlamp ZLS met ferromagnetische of elektronische transformator

Bescherming via elektronische veiligheid :

- In geval van overbelasting en boven de maximale bedrijfstemperatuur reguleert het product automatisch het vermogen door de verlichtingssterkte te verminderen.
- In geval van kortsluiting of een zeer sterke overbelasting schakelt de intervariatoren zelf uit. Na het oplossen van de storing is het product opnieuw functioneel.

Aansluiting

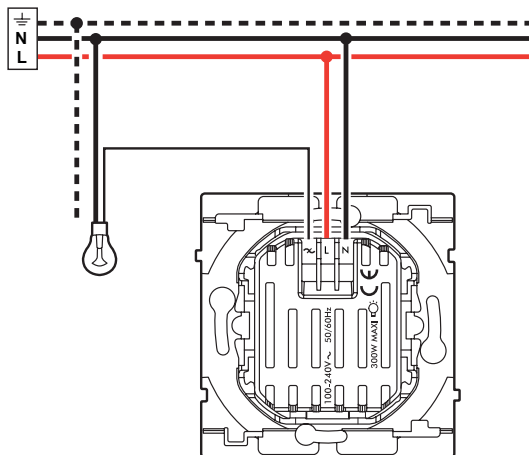

Standaardconfiguratie

Bij de eerste inschakeling worden bij een druk op de toetsen ON of OFF alle lichtpunten van de installatie "In One by Legrand" bediend. Door op Learn (1) te drukken, wordt deze algemene bedieningsfunctie geannuleerd.

(1) Toets voor programmering of aanleren.

Beschrijving

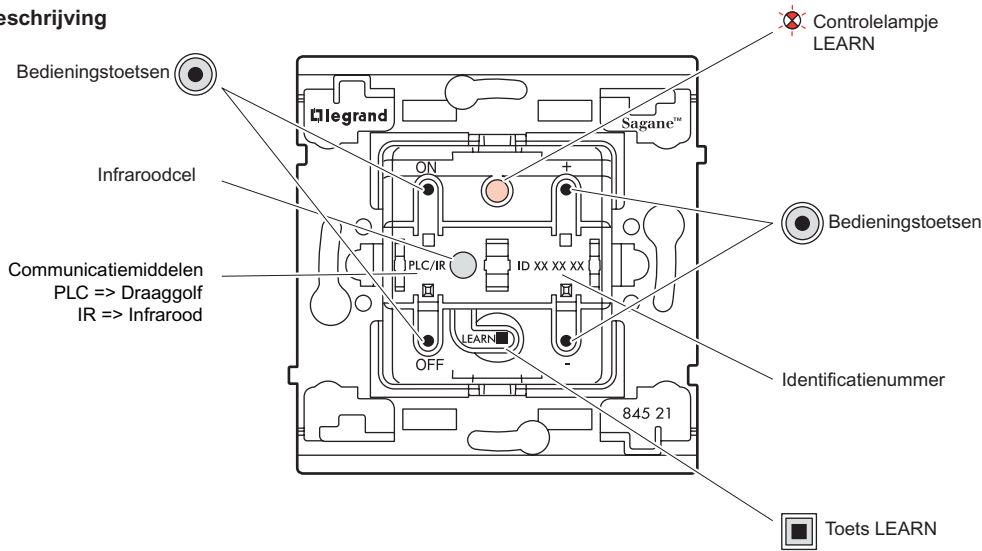

Werking

De dimmer :

- kan tegelijkertijd met behulp van de toetsen ON en OFF meerdere producten (actoren) bedienen die hier aan geassocieerd werden tijdens het aanleren⁽¹⁾, het is dan de Leider van het scenario⁽²⁾.
- kan door andere leiders bediend worden en is dan Actor van het scenario.

Als Leider:

Kunnen met de dimmer bediend worden:

- de lichtpunten met behulp van de toetsen ON, OFF.
- de hieraan toegevoegde lichtpunten, tijdens het aanleren (de actoren).

Als Actor:

De dimmer kan aan 16 verschillende scenario's deelnemen, door plaatselijk de opdrachten van andere leiders uit te voeren.

Het bezit een interface voor infrarode signalen waarmee zijn scenario's en/of andere producten van de installatie bediend kunnen worden.

Plaatselijk:

Met de intervallator kunnen de lichtpunten bediend worden met behulp van de toetsen ON, OFF, + en -, die rechtstreeks zijn aangesloten op de onderbroken faseklem.

Instelling van het lichtniveau van de toets ON (buiten de inleesprocedure):

- stel het lichtniveau in met behulp van de toetsen + en -,
- druk de toetsen + en ON 5 seconden lang gelijktijdig in
- de belasting gaat uit en gaat opnieuw aan op niveau ON.

Niveau ON wordt dan geregistreerd.

Voor het registreren van een lichtniveau tijdens het inlezen wordt stap 2 van het aanleren van het scenario:

3



Druk op
LEARN

4



Druk op de bedieningstoets
ON die aan de leider moet
zijn toegevoegd



Druk op de bedieningstoets
+ of - voor het instellen van
het gewenste lichtniveau

(1) Aanleren : actie van het associëren van producten met de bedoeling deze tegelijkertijd vanaf een centraal punt te bedienen.

Dit associëren geschiedt door toepassing van de aanleerprocedure van het scenario op pagina 7.

(2) Scenario: komt overeen met alle producten (actoren) die bij een bedieningstoets horen.

Aanleren van het scenario

Stap 1: beginnen met aanleren (op de LEIDER)



Stap 2: voeg een actor toe aan het scenario (op de ACTOR)



Stap 3: het scenario registreren (op de LEIDER)



Wijziging van een scenario

Stap 1: het scenario openen (op de LEIDER)



Stap 2: de staat van een actor van het scenario wijzigen (op de ACTOR)



Stap 3: het scenario registreren (op de LEIDER)

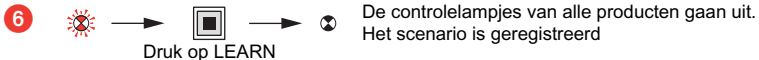

Wissen van een scenario





Wis alle scenario's die verbonden zijn met de bedieningstoets (op de LEIDER)





Wis alle scenario's die bij dit product horen (op de LEIDER)





Legende

-  Het controlelampje gaat uit
-  Het controlelampje knippert langzaam
-  Het controlelampje knippert snel
-  Het controlelampje flitst

Characteristics

Voltage	100 - 240 V~
Frequency	50 - 60 Hz
	2 x 1,5 mm ²
	Depth = 40 mm min.
Standard	EN 50065 Power line carrier IEC 60669-2-1
	+ 5°C to +45°C

Loads

	① 	② 	③ 
110 V	150 W	150 W	150 W
230 V	300 W	300 W	300 W

- ① Lampe incandescente
- ② Lampe halogène
- ③ Lampe halogène TBT à transformateur ferromagnétique ou électronique

Protection by electronic device:

- If there is an overload and it is above the max. operating temperature, the product automatically regulates the power by lowering the lighting.
- If there is a short-circuit or a very high overload, the dimmer switches itself off. Once the fault has been eliminated, the product is once again operational.

Connection

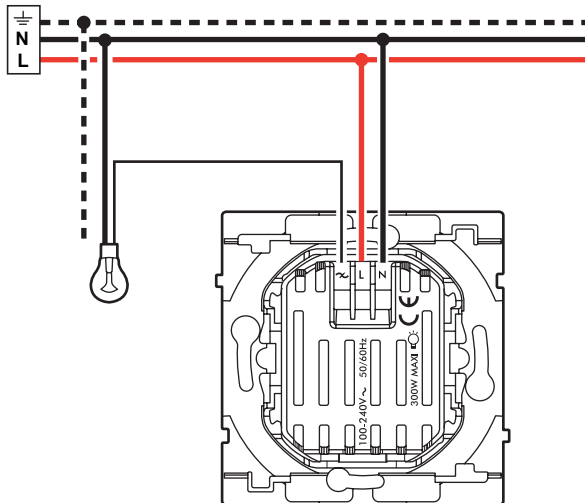

Factory configuration

The first time it is switched on, pressing the ON or OFF keys controls all the lighting points in the "In One by Legrand" installation. Pressing Learn⁽¹⁾ cancels this general control function.

(1) Programming or learn key.

Description

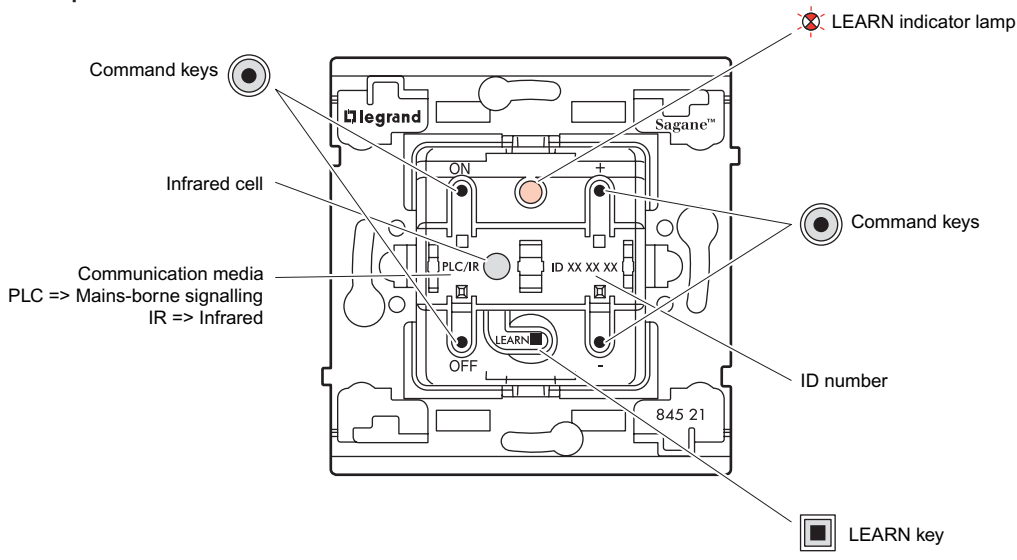

Operation

The dimmer switch:

- Using its ON and OFF keys it can simultaneously control a set of products (actors) that have been associated with it during the learn phase⁽¹⁾. It is then the **Leader** of the scenario⁽²⁾.
- Can be controlled by other Leader products. It is then an **Actor**.

As Leader:

The dimmer switch can control:

- The lighting points that are directly connected to the open phase terminal, using the ON, OFF, + and - keys.
- The lighting points associated with it (the actors) using the ON and OFF keys.

As Actor:

The remote control dimmer can participate in 16 different scenarios, executing the commands from the other Leaders.

Locally:

The dimmer switch can control:

- The lighting points that are directly connected to the open phase terminal, using the ON, OFF, + and - keys.
- When the remote control dimmer is used in local control, it is possible to record a default light level.

Setting the light level of the ON button (excluding learning procedure) :

- Set the level using the + and - buttons
- Press the + and ON buttons at the same time, for 5 seconds
- The load will extinguish and light up again at the ON level

The ON level is now saved.

To record a light level during the learn phase, step 2 of the "learn scenario" becomes:

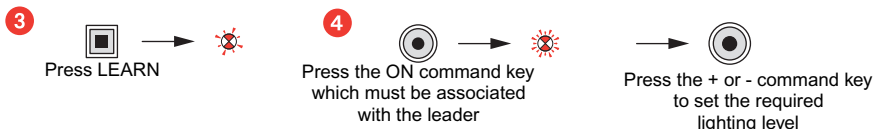

(1) Learn phase: Operation to associate products so that they can be controlled simultaneously from a central point. This association is carried out by applying **the learn scenario** procedure on page 11.

(2) Scenario: Corresponds to the set of products (actors) that are associated with a command key.

Learn scenario

Step 1: Start the learn phase (on the LEADER)



Step 2: Add an actor to the scenario (on the ACTOR)

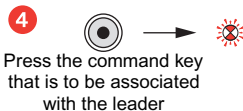

To add a number of products to the scenario, repeat operations 3 and 4 for each actor.

Step 3: Record the scenario (on the LEADER)



Modification of a scenario

Step 1: Open the scenario (on the LEADER)



The indicator lamps of all the products in the scenario blink.

Step 2: Modify the state of an actor in the scenario (on the ACTOR)



or
To remove the product from the scenario, go to step 3

Step 3: Record the scenario (on the LEADER)

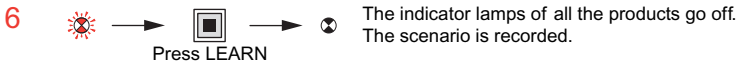

Clearing a scenario

Clear all the scenarios linked with the command key (on the LEADER)

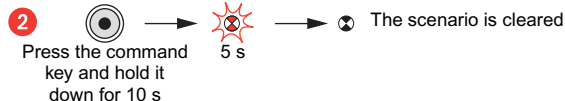

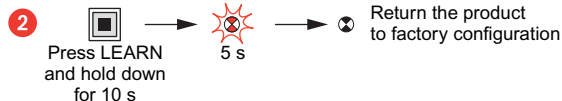

Clear all the scenarios linked to this product (on the LEADER)



Key

 The indicator lamp goes off

 The indicator lamp blinks slowly

 The indicator lamp blinks quickly

 The indicator lamp flashes